

FEATURES

- **Wide Band:** 50 MHz to 2.2 GHz
- **NF (ext match):**
 - 1.2 dB @ 0.1 GHz
 - 1.0 dB @ 0.5 GHz
 - 1.1 dB @ 1.6 GHz
 - 1.2 dB @ 2.0 GHz
 - 1.3 dB @ 2.2 GHz
- **P-1dB:** 15 dBm
- **OIP3:** 33 dBm
- **High Gain:** 15 dB
- **Bias Condition:** VDD = 3V
IDD = 65mA
- **50-Ohm On-chip Matching**
- **Unconditionally Stable: 50 MHz to 7 GHz**
- **Narrow-Band Optimization with External Tuning**
- **Frequency Extension to 50 MHz with External Choke**
- **Surface-Mount Hermetic 8-Lead, 87 Package**

APPLICATIONS

- **Wide-band Communication Systems**
- **Commercial Wireless Systems**
- **Iridium Satellite Communications**
- **Test Instrumentation**
- **Surveillance Systems**

DESCRIPTION

The MLA-0522A-87 is a partially matched single-stage broadband Low-Noise MMIC amplifier utilizing high-reliability low-noise GaAs PHEMT technology. The packaged MMIC is suited for Iridium Satellite Communications, Instrumentation, Wideband Systems and also many commercial wireless applications where low-noise figure and high-dynamic range is desirable. It has excellent gain 15 dB and Noise Figure 1.1 dB @ 1.6 GHz which is ideally suited for Iridium Satellite Band applications. P-1dB is 15 dBm and OIP3 is 30 dBm @ 1.6 GHz. It has partial input match and full output match on-chip providing flexibility to optimize NF performance using external input match. The bias current is adjustable with gate voltage down to 30mA. with good performance. Other package options are available. Contact factory for details.

ELECTRICAL SPECIFICATIONS: VDD=+3.0V, VG=0V, IDD=70mA, Ta=25 C, ZO=50 ohm ⁽¹⁾

| PARAMETER | TEST CONDITIONS | TYPICAL DATA | UNITS |
|---|---|---------------------------------|---------|
| Frequency Range | | 0.05-2.2 | GHz |
| Gain | 0.05 - 1 GHz 1.6 GHz | 17.5 15 | dB |
| Gain Flatness | 0.05 - 0.9 GHz 1 - 2 GHz | 1.0 1.3 | +/- dB |
| Input Return Loss | 0.05 GHz 1 GHz 1.6 GHz 2 GHz 2.2 GHz | 10 14 18 19 13 | dB |
| Output Return Loss | 0.05 GHz 1 GHz 1.6 GHz 2 GHz 2.2 GHz | 11 17 18 14 12 | dB |
| Output P1dB | | 15 | dBm |
| Output IP3 @ 0 dBm/ tone, 1 MHz separation | 0.05 GHz 0.5 GHz 1.6 GHz 2 GHz | 33 33 30 29 | dBm |
| Noise Figure (Ext Input matched for 1.6 GHz) | 0.1 GHz 0.5 GHz 1.6 GHz 2 GHz 2.2 GHz | 1.3 1.0 1.1 1.2 1.3 | dB |
| Operating Bias Conditions: VDD IDD | VG = -0.04V | +3 65 | V mA |
| Stability Factor K | 0.05 to 7 GHz | > 1 | |

(1) All data is measured on 50 Ohm evaluation board with external Input match, Bias Choke, Bypass and DC blocking caps. See application schematic and evaluation PCB layout.

TYPICAL RF PERFORMANCE: $V_{DD}=+3.0V$, $V_G=-0.04V$, $I_{DD}=65mA$, $T_a=25\text{ C}$, $Z_0=50\text{ ohm}$ ⁽¹⁾

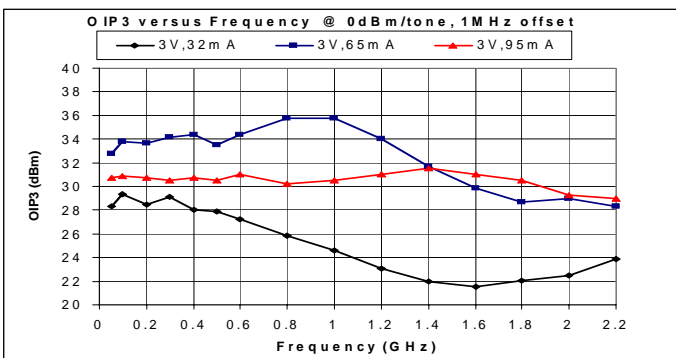
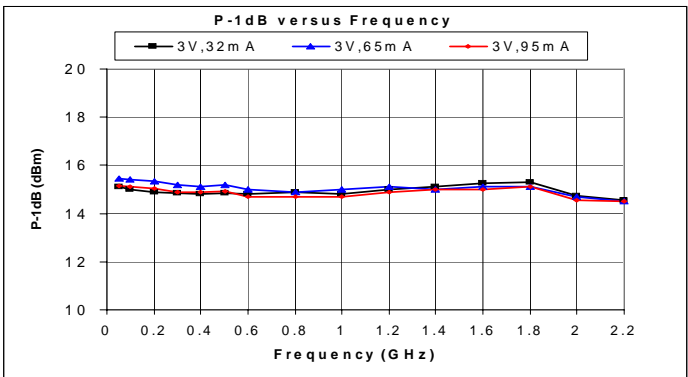
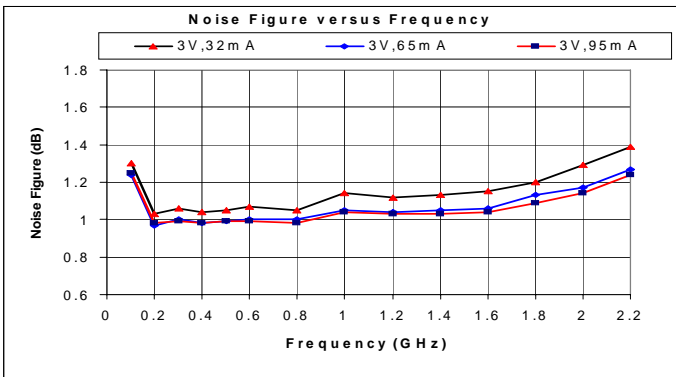
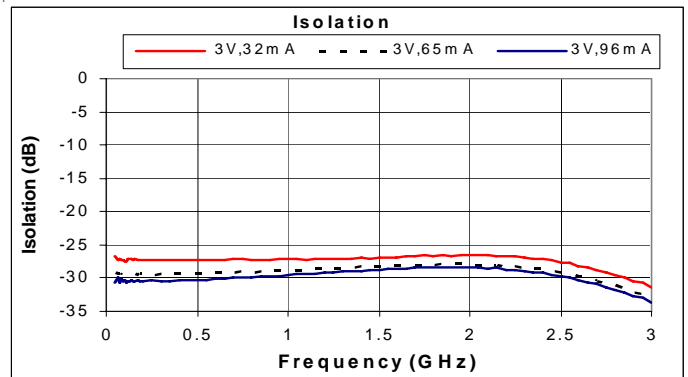
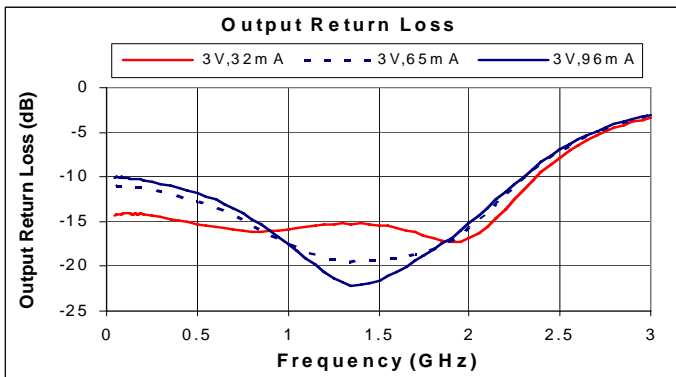
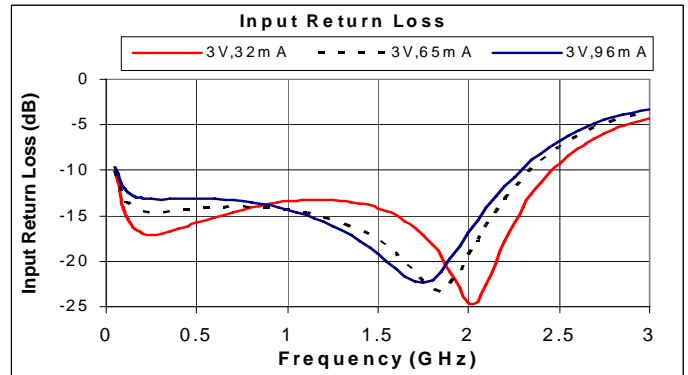
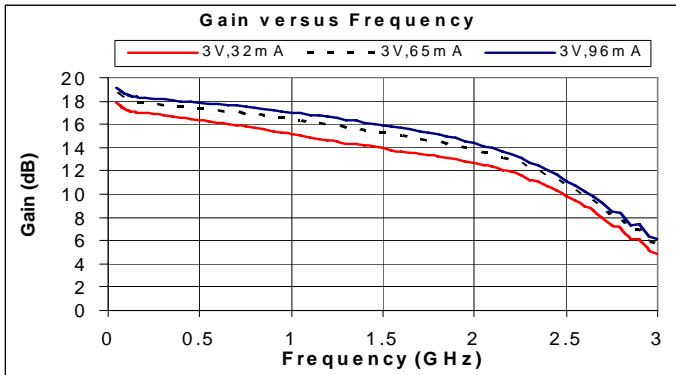

APPLICATION SCHEMATIC

MLA052-2A 87 PKG APPLICATION CIRCUIT SCHEMATIC
Input /Output Matching Tuned for 1.6 GHz but usable broadband from 50 MHz-2.2 GHz

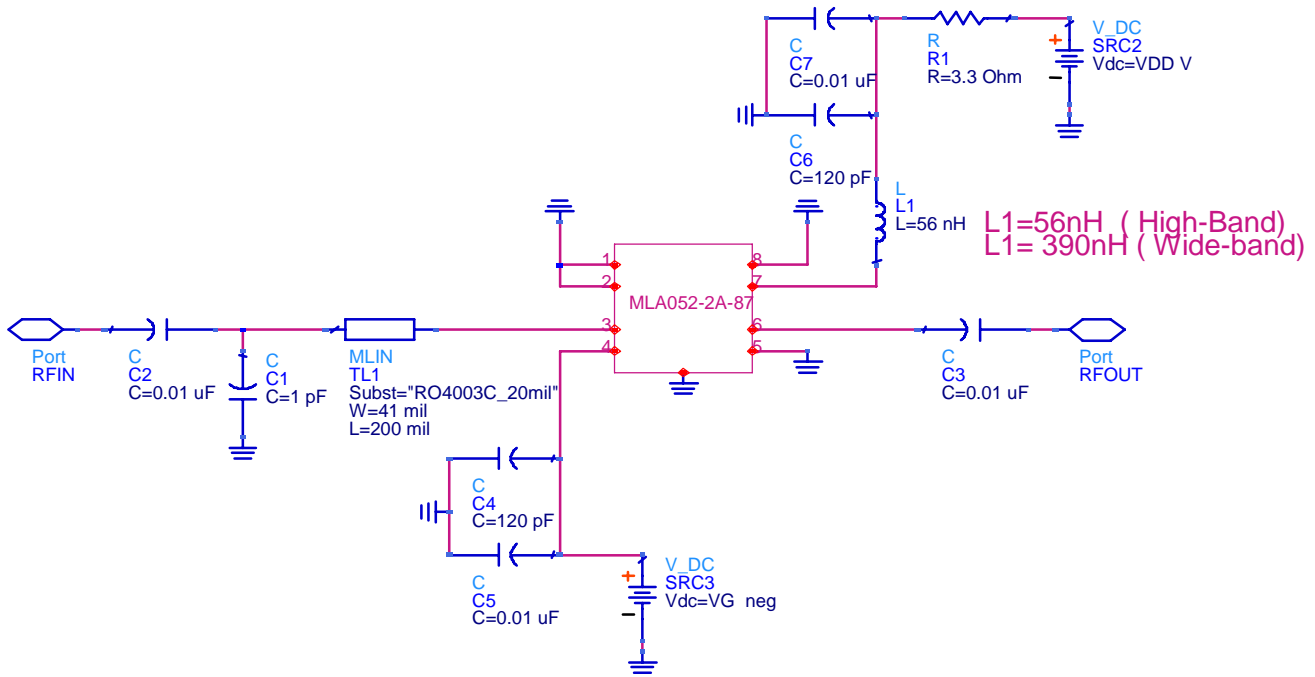

Notes:

- 1) Please contact factory sales for additional information on external components and matching for improved performance.

ABSOLUTE MAXIMUM RATINGS

| SYMBOL | PARAMETERS | UNITS | MAX |
|---------|--------------------------------|-------|------------|
| VDD | Drain Voltage | V | 6 |
| IDD | Drain Current | mA | 150 |
| Pdiss | DC Power Dissipation | W | 0.6 |
| Pin max | RF Input Power | dBm | +17 |
| Toper | Operating Case/Lead Temp Range | °C | -40 to +85 |
| Tch | Channel Temperature | °C | 150 |
| Tstg | Storage Temperature | °C | -60 to 150 |

Exceeding any on of these limits may cause permanent damage.

MECHANICAL INFORMATION

87 Package Outline Drawing

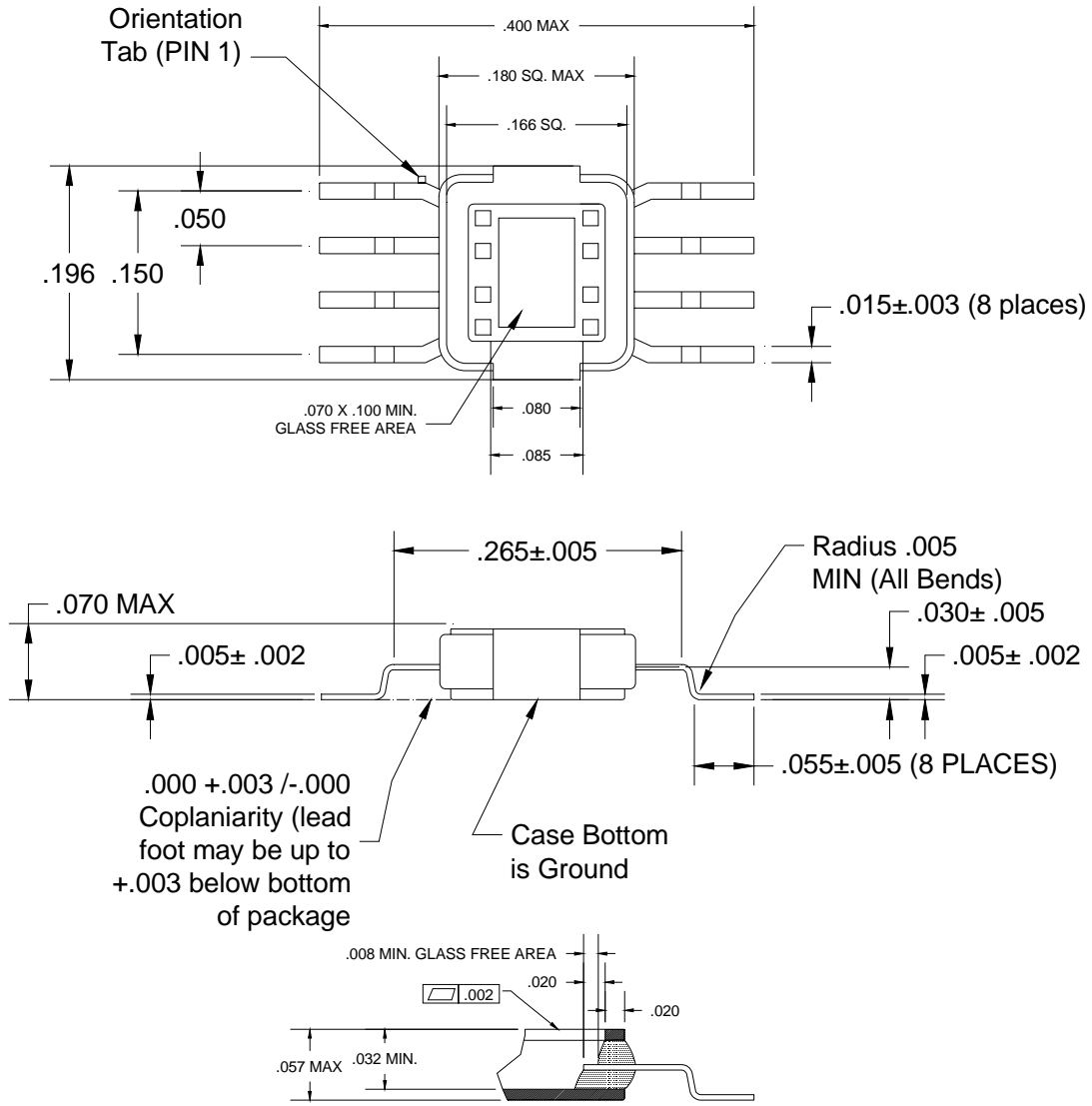

.000 +.003 /-.000
Coplanarity (lead
foot may be up to
+.003 below bottom
of package)

Case Bottom
is Ground

Dimensions are in inches

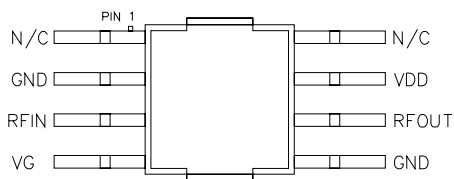

Functional Diagram

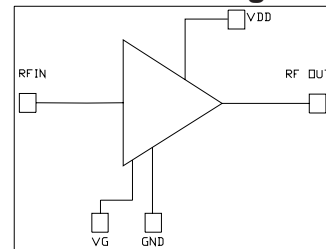

EVALUATION BOARD LAYOUT

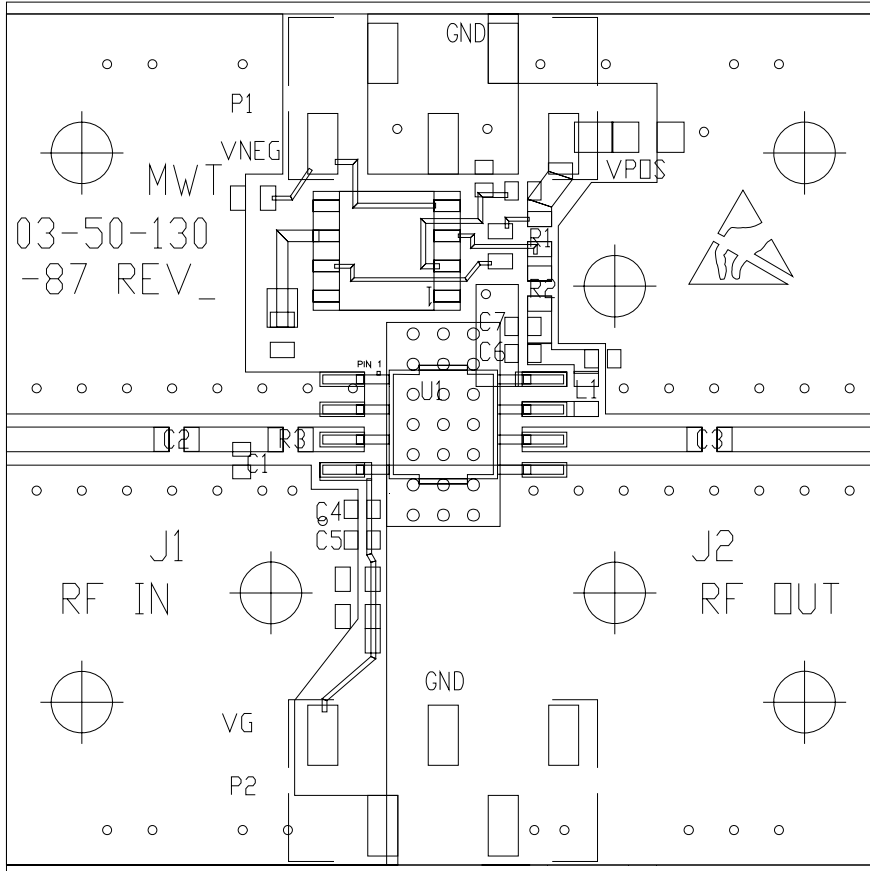

MLA-0522A-87 APPLICATION BOARD

PARTS LIST:

- R1: 3.3 ohm, 0603, 0.1W
- R2: 000 ohm, 0603
- R3: 000 ohm, 0603
- C1: 1.0 pF AVX LOW-ESR 04023U1R0BAT2A
- C4,C6: 120 pF AVX 04025A121JAT2A
- C2,C3,C5,C7: 0.012 uF AVX 0402YC123KAT2A
- L1: 56 nH, COILCRAFT 0603CS-56NXJL (High-Band)
390 nH, COILCRAFT 0603LS-391XJL (Wide-Band)
- P1, P2: DC CONNECTOR TSM-105-01-SSV
- J1, J2: RF CONNECTOR JOHNSON, 142-0701-841
- U1: MLA-0522A-87, 8L, 87 HERMETIC PACKAGE

87 PACKAGE PIN LABEL/FUNCTION:

- PIN 1: GND OR N/C
 - PIN 2: GND
 - PIN 3: RF INPUT
 - PIN 4: VG GATE BIAS INPUT
 - PIN 5: GND
 - PIN 6: RF OUT
 - PIN 7: VDD DRAIN BIAS INPUT
 - PIN 8: GND OR N/C
- BACKSIDE: DC/RF GROUND

APPLICATIONS NOTES:

C1 MUST BE PLACED APPROX. 200MIL FROM THE LEAD 3 SOLDER JUNCTION ON THE 50 OHM MICROSTRIPLINE AS SHOWN AND LOCATION CAN BE TUNED FOR BEST INPUT RETURN LOSS AT 1.6 GHZ

R1 RESISTOR IS REQUIRED FOR DC/RF STABILITY

L1 SERVES AS RF CHOKER

C2, C3 ARE USED FOR DC BLOCKING

C4,C5, C6 & C7 SERVE AS BYPASS CAPS

87 PACKAGE BACKSIDE MUST BE SOLDERED WELL TO PCB GROUND VIAS FOR GOOD RF/DC GROUNDING

PACKAGE LEADS MUST BE SOLDERED STARTING FROM LEAD BEND JUNCTION

PCB MATERIAL: R04003C, 20MIL THICK, 2-LAYER, 1 OZ COPPER BOTH SIDES

BOARD SIZE: 1.45 x 1.45 in