

Features:

- Ideal for DC – 4.0 GHz High Linearity / High Dynamic Range Applications
- Excellent RF Performance:
 - 40 dBm IP3
 - 65 dBc ACPR
 - 25 dBm P1dB
 - 17 dB SSG @ 2000MHz
 - 0.9 dB NF @ 2000MHz
- MTTF>100 years @ ambient temperature 85 °C
- Lead Free RoHS Compliant Surface-Mount SOT-89 Package



Description:

The MwT-A989 is a high linearity GaAs MESFET device in low cost SOT89 package that is ideally suited for high dynamic range LNA applications. The applications include 2G, 2.5G, and 3G wireless infrastructure standards, such as GSM, TDMA, cdma, Edge, cdma2000, WCDMA, TD-SCDMA, and UMTS base stations. This product is also ideal for high data rate wireless LAN infrastructure applications, such as high QAM rate 802.11 WiFi and 802.16 WiMax base stations and APs (Access Points). In addition, the product can be used for point-to-point microwave communications links. The third order intercept performance of the MwT-A989 is excellent, typically 14 dB above the 1 dB power gain compression point. The NF is as low as 0.6 dB at 900 MHz. The chip is produced using MwT's proprietary high linearity device design and process with reliable metal system. All chips are passivated using MwT's patented "Diamond-Like Carbon" process for increased durability.

Electrical Specifications⁽¹⁾: @ $V_{ds}=6.0V$, $I_{ds}=100mA$, $T_a=25\text{ }^\circ\text{C}$

SYMBOL	PARAMETERS & CONDITIONS	FREQ	UNIT	TYP
SSG	Small Signal Gain	2GHz	dB	17
P1dB	Output Power @ 1 dB Compression	2GHz	dBm	25
PAE	Power Added Efficiency	2GHz	%	40
IP3	Third Order Intercept Point	2GHz	dBm	40
Noise Figure	Noise Figure (2)	2GHz	dB	0.9

(1) with tuners at input and output

(2) $V_{ds}=4.0\text{ V}$ @ $I_{ds}=50mA$

DC Specifications: ($T_a = 25^\circ\text{C}$)

SYMBOL	PARAMETERS & CONDITIONS	UNITS	MIN	TYP	MAX
IDSS	Saturated Drain Current Vds=3.0 V Vgs=0.0 V	mA	100		200
Gm	Transconductance Vds=2.0 V Vgs=0.0 V	mS	90	120	
Vp	Pinch-off Voltage Vds=3.0 V Ids=5.0 mA	V		-2.5	-5.0
BVGSO	Gate-to-Source Breakdown Voltage Igs= -1.0 mA	V	-5.0	-10.0	
BVGDO	Gate-to-Drain Breakdown Voltage Igd= -1.0 mA	V	-6.0	-10.0	
Rth	Thermal Resistance	$^\circ\text{C}/\text{W}$		75	

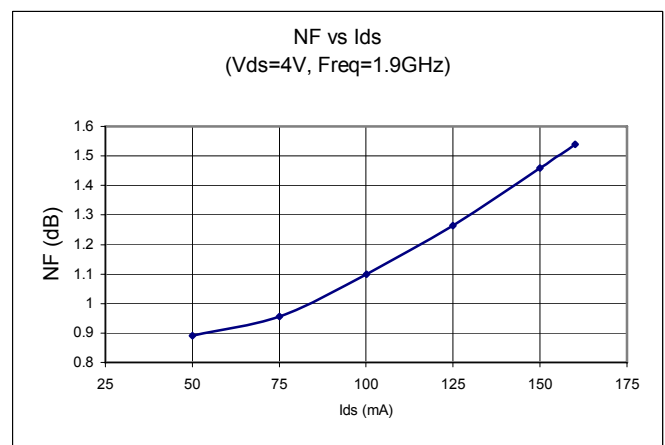
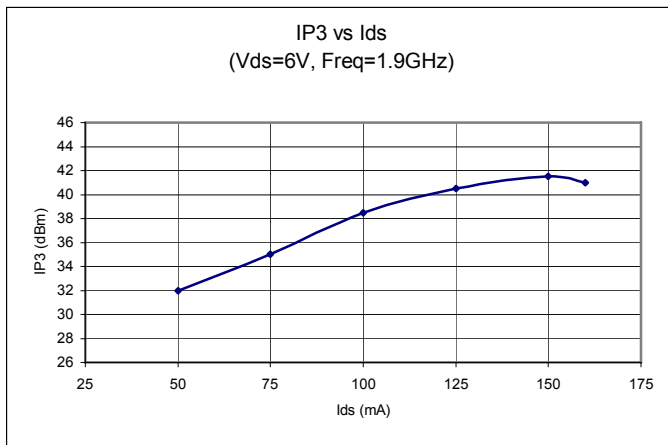

SOT-89 Outline Diagram

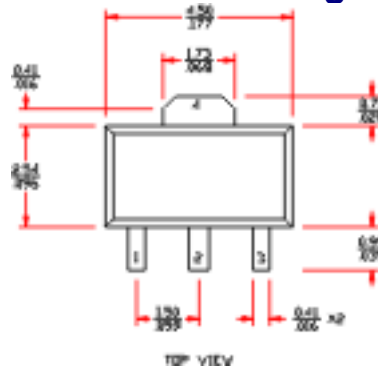

1: Gate; 2,4: Source; 3: Drain
Dimensions in mm/inch

Absolute Maximum Rating: ($T_a = 25\text{ }^\circ\text{C}$)*

SYMBOL	PARAMETERS	UNITS	ABSOLUTE MAXIMUM
Vds	Drain-Source Voltage	V	8
Vgs	Gate-Source Voltage	V	-6 to +0.8
Ids	Drain Current	mA	200
Igs	Gate Current	mA	1
Pdiss	DC Power Dissipation	W	1.6
Pin max	RF Input Power	dBm	+25
Tch	Channel Temperature	$^\circ\text{C}$	150
Tstg	Storage Temperature	$^\circ\text{C}$	-65 to 150

*Operation of this device above any one of these parameters may cause permanent damage.

Noise Parameters: ($V_{ds}=4\text{V}$, $I_{ds}=50\text{mA}$, $T_a=25\text{ }^\circ\text{C}$)

Freq. MHz	Fmin dB	Γ_o		Rn/50
		Mag.	Ang	
900	0.48	0.39	30.0	0.31
2000	0.71	0.30	77.6	0.19
2500	0.79	0.27	87.6	0.17
3000	0.95	0.20	120	0.15
3500	1.18	0.17	155.1	0.14

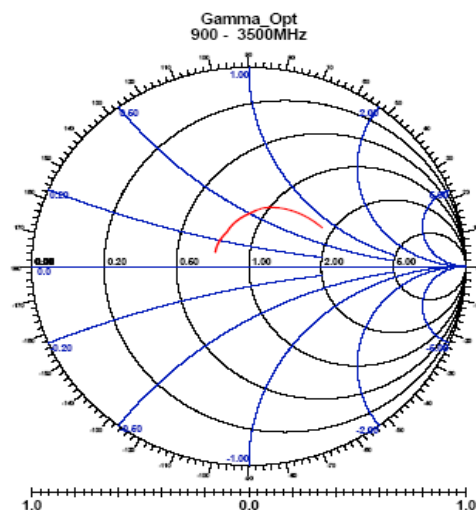
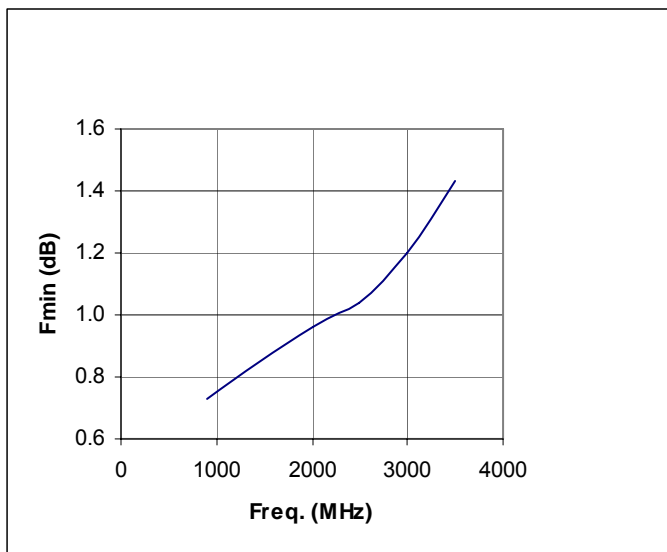



Typical Scattering Parameters:

(V_{ds}=6V I_{ds}=100mA T_a =25°C Reference Planes at Leads)

Freq	S11		S21		S12		S22	
	Mag	Ang	Mag	Ang	Mag	Ang	Mag	Ang
0.25	0.97	-21.10	8.65	162.90	0.02	72.16	0.42	-13.41
0.50	0.92	-40.59	8.17	146.64	0.03	62.46	0.40	-26.33
0.75	0.88	-57.88	7.61	132.26	0.04	53.74	0.38	-37.09
1.00	0.83	-73.26	7.03	119.43	0.05	45.80	0.35	-46.10
1.25	0.79	-87.47	6.49	107.77	0.06	38.71	0.32	-53.38
1.50	0.75	-101.44	6.08	96.74	0.07	32.17	0.30	-59.46
1.75	0.71	-115.59	5.75	85.99	0.08	25.47	0.26	-64.96
2.00	0.69	-130.57	5.43	74.83	0.09	18.59	0.21	-70.46
2.25	0.66	-146.63	5.10	63.41	0.09	11.33	0.15	-76.21
2.50	0.64	-163.51	4.77	52.09	0.10	4.09	0.09	-81.69
2.75	0.63	179.30	4.42	41.25	0.10	-3.12	0.03	-83.23
3.00	0.62	162.86	4.05	30.86	0.10	-10.17	0.04	80.72
3.25	0.63	148.69	3.71	21.04	0.10	-16.52	0.09	78.74
3.50	0.64	135.69	3.37	11.97	0.10	-22.91	0.14	73.45
3.75	0.65	124.62	3.10	3.58	0.10	-28.34	0.19	67.16
4.00	0.67	114.98	2.86	-4.10	0.10	-33.17	0.22	60.77
4.25	0.68	106.55	2.68	-12.17	0.10	-37.72	0.24	55.22
4.50	0.69	98.69	2.51	-20.13	0.10	-42.02	0.27	50.11
4.75	0.70	90.91	2.35	-28.14	0.10	-46.72	0.29	45.05
5.00	0.71	83.13	2.20	-36.12	0.10	-51.36	0.31	40.05
5.25	0.72	75.02	2.07	-44.09	0.10	-56.58	0.34	34.10
5.50	0.74	67.06	1.95	-52.36	0.10	-62.90	0.36	28.81
5.75	0.75	59.38	1.83	-60.90	0.10	-67.21	0.38	22.34
6.00	0.77	51.04	1.70	-69.64	0.10	-73.45	0.41	15.46



APPLICATION CIRCUIT INFORMATION

The information provided in this section following is intended to demonstrate various applications for the MwT-A989. For this purpose, examples of two types of designs are presented in the following pages:

- (A) Low-noise balanced amplifier for the frequency band of 1930-1990 MHz.
- (B) General-purpose feedback amplifiers designed for the frequency bands of 800-1000, 1900-2100, 2400-2600, and 3500-3700 MHz.

Given below are circuit schematics and list of materials for the above-mentioned designs. The typical RF performance is also provided.

(A) LOW NOISE AMPLIFIER CIRCUIT SCHEMATIC

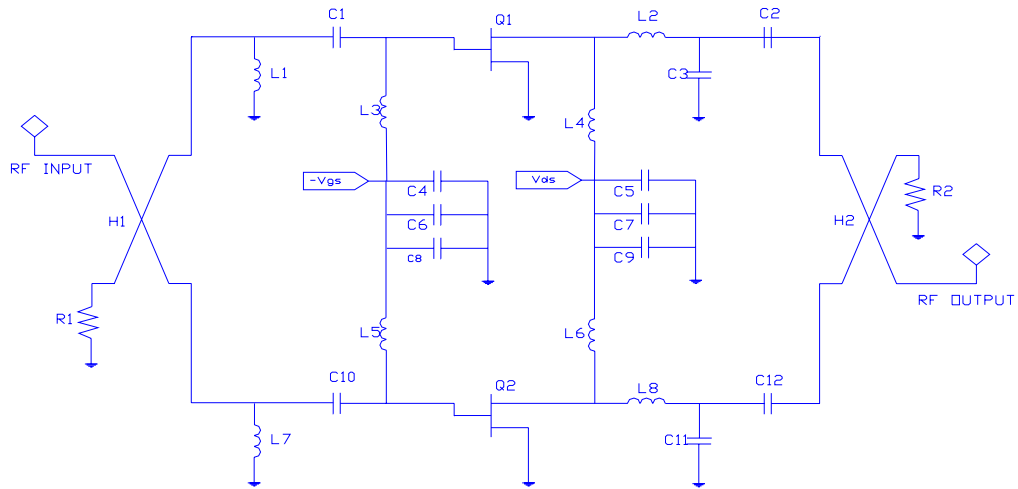

BILL OF MATERIALS

Reference Designation	Value	Unit	Part	Size
C4, C5	100	pF	Chip Capacitor	505
C6, C7	1000	pF	Chip Capacitor	505
C8, C9	0.1	$\mu\Phi$	Chip Capacitor	505
C1, C2, C10, C12	20	pF	Chip Capacitor	505
C3, C11	0.6	pF	Chip Capacitor	505
L1, L7	5	nH	Chip Inductor	603
L2, L8	1.8	nH	Chip Inductor	603
L3, L4, L5, L6	100	nH	Chip Inductor	603
R3, R4	50	Ohm	Chip Resistor	603
H1, H2	-	-	Quadrature Hybrid	0.35" x 0.56"
Q1, Q2	MWT-A989	-	MESFET	SOT89

TYPICAL RF PERFORMANCE
(Vds=5.0V, Ids=100mA, Ta=25°C)

Freq MHZ	Gain dB	ΔG dB	NF dB	P1dB dBm	IP3 dBm	VSWR	
						In	Out
1930-1990	15	+/- 0.2	1.2	24	39	1.2:1	1.2:1

(B) FEEDBACK AMPLIFIERS CIRCUIT SCHEMATIC

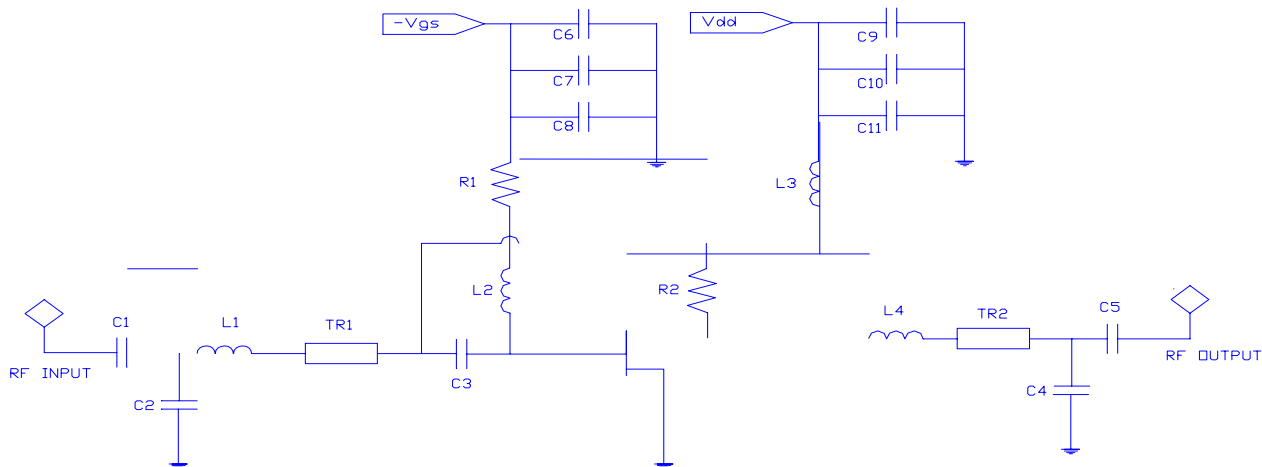

BILL OF MATERIALS

Reference Designation	Value				Unit	Part	Size
	0.80-1.00	1.90-2.10	2.40-2.60	3.50-3.70			
C8, C11	100	100	100	100	pF	Chip Capacitor	0505
C7, C10	1000	1000	1000	1000	pF	Chip Capacitor	0505
C6, C9	0.1	0.1	0.1	0.1	μF	Chip Capacitor	0505
C1 C5	33	33	33	22	pF	Chip Capacitor	0505
C2	N/I	1.2	1.2	0.8	pF	Chip Capacitor	0505
C3	100	33	3.9	1.5	pF	Chip Capacitor	0505
C4	N/I	0.3	0.2	0.1	pF	Chip Capacitor	0505
L1	10	2.8	1.2	0	nH	Chip Inductor	0603
L2, L3	100	100	10	10	nH	Chip Inductor	0603
L4	0	0	0	0	nH	Chip Inductor	0603
R1	50	50	50	50	Ohm	Chip Resistor	0603
R2	1000	1000	500	330	Ohm	Chip Resistor	0603
TR1	0	0	12	37	Deg	50 Ohm TRL	-
TR2	0	0	17	55	Deg	50 Ohm TRL	-
Q	MWT-A989	MWT-A989	MWT-A989	MWT-A989	-	MESFET	SOT89

N/I: Not Installed



TYPICAL RF PERFORMANCE
(V_{ds} = 6.0V, I_{ds} = 100 mA, T_a = 25 °C)

FREQ (MHz)	800-1000	1900-2100	2400-2600	3500-3700
SSG (dB)	15.0 (Ref.: Fig. 1A)	13.8 (Ref.: Fig. 2A)	13.0 (Ref.: Fig. 3A)	13.5 (Ref.: Fig. 4A)
R/L, In (dB)	-12 (Ref.: Fig. 1B)	-11 (Ref.: Fig. 2B)	-11 (Ref.: Fig. 3B)	-10 (Ref.: Fig. 4B)
R/L, Out (dB)	-11 (Ref.: Fig. 1B)	-11 (Ref.: Fig. 2B)	-11 (Ref.: Fig. 3B)	-10 (Ref.: Fig. 4B)
NF (dB)	2.6	3.3	3.4	3.5
P1dB (dBm)	24	23.0	23.0	23.0
IP3 (dBm)	39	37	37	36

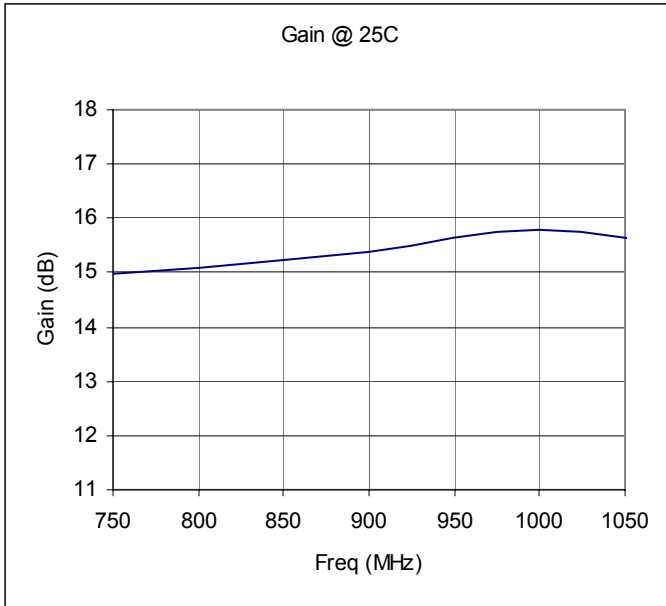

Figure 1A: Gain, 800-1000 MHz

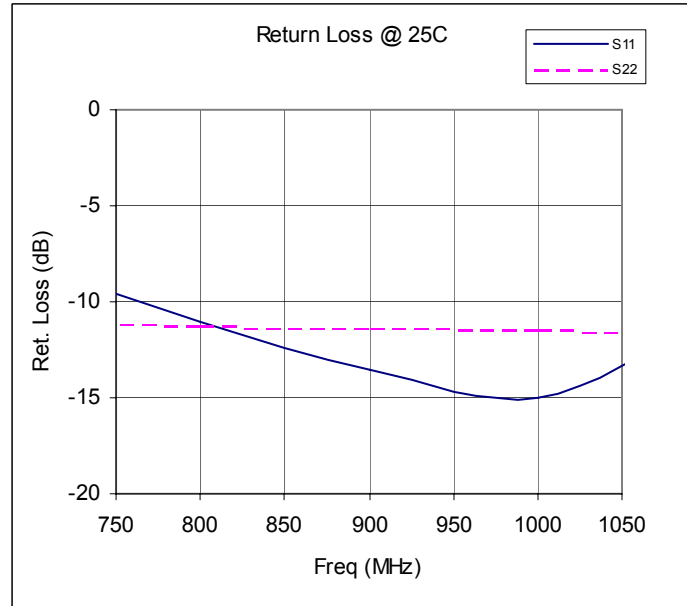

Figure 1B: Ret. Loss, 800-1000 MHz

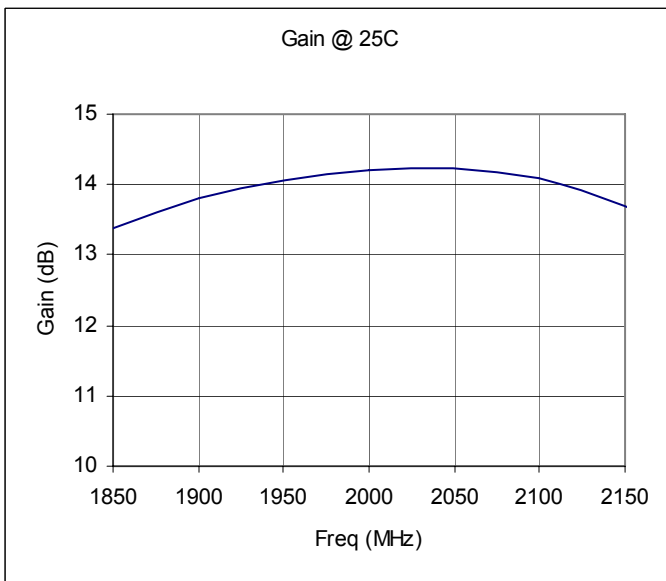

Figure 2A: Gain, 1900-2100 MHz

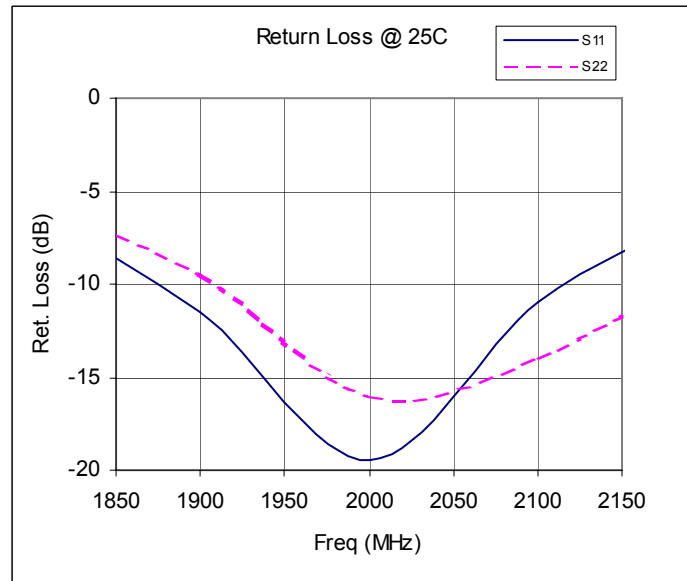

Figure 2B: Ret. Loss, 1900-2100 MHz

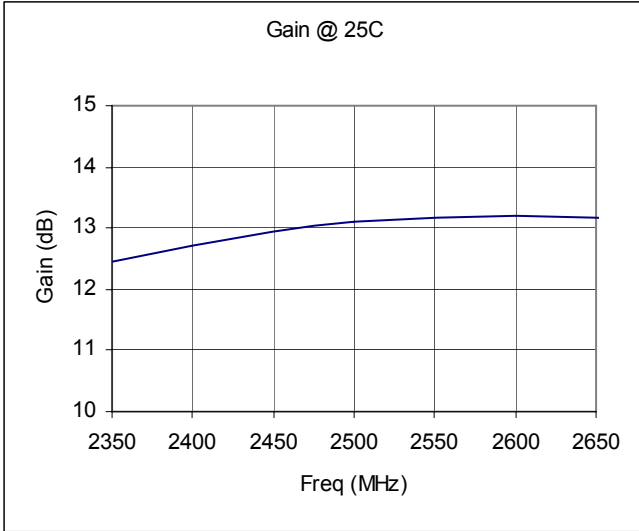

Figure 3A: Gain, 2400-2600 MHz

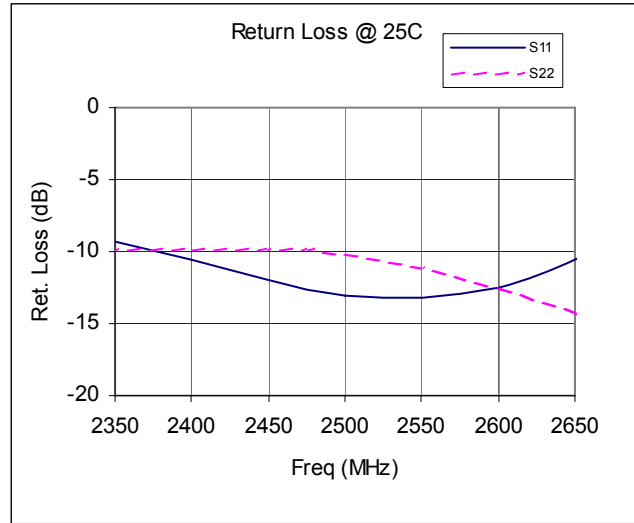

Figure 3B: Ret. Loss, 2400-2600 MHz

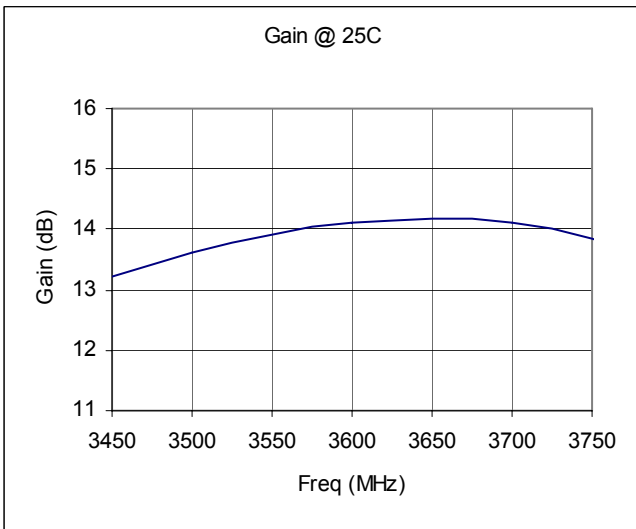

Figure 4A: Gain, 3500-3700 MHz

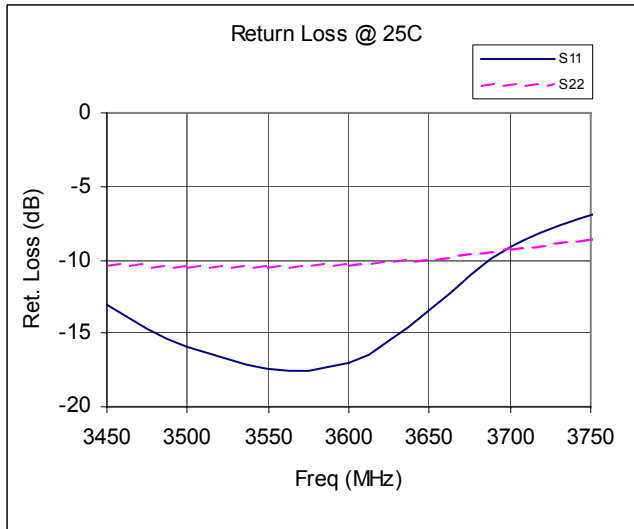

Figure 4B: Ret. Loss, 3500-3700 MHz