

## Model Features

- Broadband (DC to 40 GHz)
- Large-signal model (Modelithics-Enhanced Angelov)
- Measurement Validations:
  - Pulsed I-V (25C to 85C)
  - Multi-bias S-parameters (25C to 85C)
  - Load pull (25C)
- Advanced model feature: enabling intrinsic I-V sensing
- IP3 validated against MwT spec

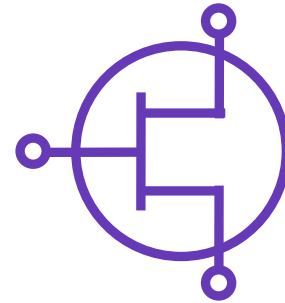

**HMT-MWT-MWT3F-001**  
**MwT-3F**  
**Discrete GaAs MESFET**

## Model Description

The HMT\_MWT\_MWT3F\_001 is a non-linear model for the MwT-3F a discrete 300 um GaAs MESFET (additional information is available at [www.mwtinc.com](http://www.mwtinc.com)). The model is based on the extraction of a customized Angelov non-linear model that is validated against the following Modelithics measurement data: I-V, S-parameters & load pull.

## Technical Notes

- Model is optimized for 2, 4 and 7V operation (26.1mA (30% IDSS), 43.5 mA (50% IDSS) and 52.2mA (60% IDSS)).
- Model Parameters:
  - **VDSQ**: For setting the optimum bias point of the model (default=7V).
  - **Temperature**: represents the backside ambient temperature, validated at 25C and 85C.
  - **Self\_heat**: switch for the electrothermal model (0 or 1), 0= self-heating is turned off, 1 (default)= self-heating is turned on.
  - **BWremoval**: 0 includes wire assembly (only) used in measurements, 1 (default) sets model reference planes at the center of the gate, drain, and source bond pads.

## Model Representation

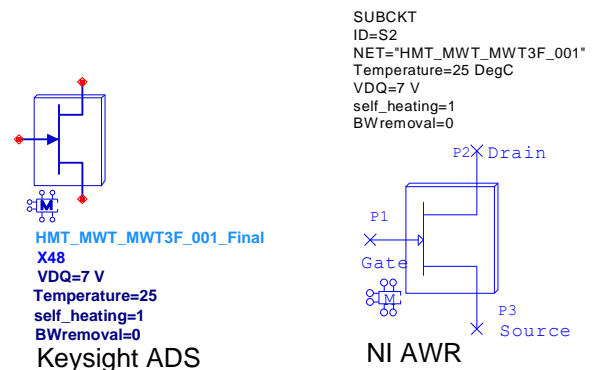

## Reference Planes

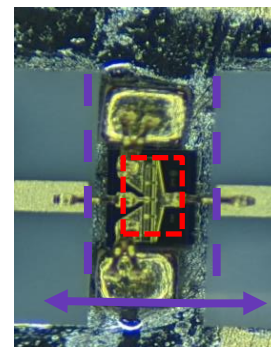

Model and Measurement Reference Planes (BWremoval=1)

Model and Measurement Reference Planes (BWremoval=0)

## Model Simulation Settings

- **I-V**: self\_heat: 0 for I-V simulations (self heating model turned OFF), Temperature=25C
- **S-Parameters**: self\_heat: 1 for CW bias, Temperature=25C
- **Load Pull Validations and Single-tone Power sweeps**: self\_heat: 1 for CW bias; Temperature=25C.



DC I-V Characteristics: VDSQ = 7V, 25C

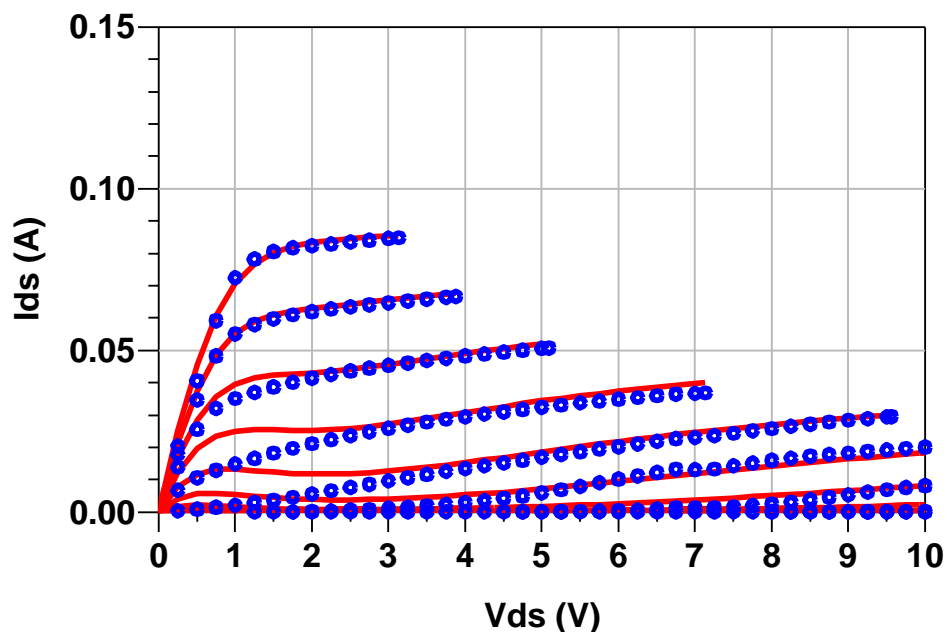

Legend: Red Solid lines - Model data, O Symbols - Measured data  
 Simulated at 25C with VGS varying from -4 to 0V in steps of 0.4V,  
 VDS varying from 0 to 10V in steps of 0.25V. Model self\_heat = 0.

Model vs. Measurement Temperature IV Characteristics

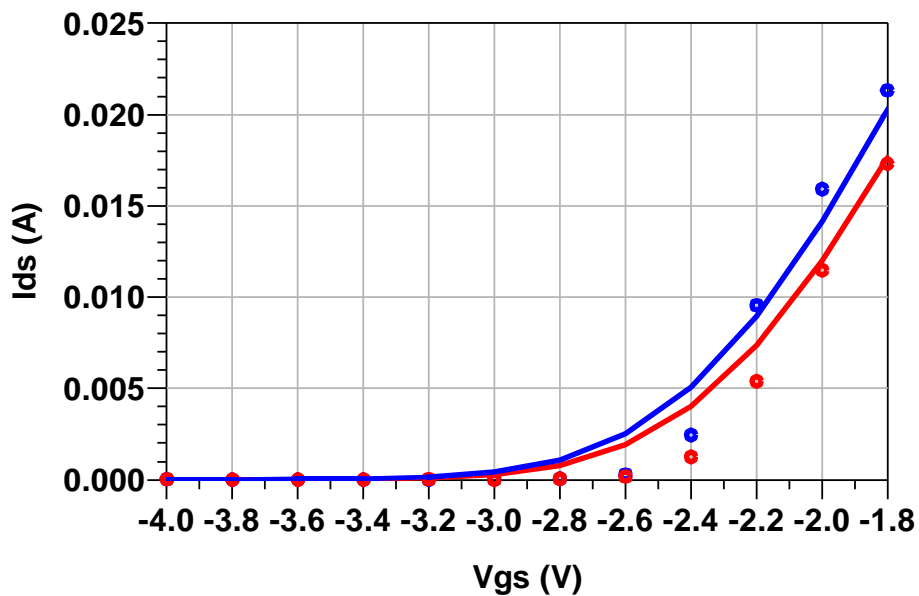

Legend: Red Solid lines: 85C, Blue Solid lines: 25C.  
 Solid lines - Model data, Symbols - Measured data  
 Simulated at 25C and 85C, VDSQ of 7V. Model self\_heat = 0, BWremoval = 0

S-Parameters Model vs. Measured:

VDS = 7V, VGS = -0.82V, IDS = 52.2mA (60% IDSS), 25C

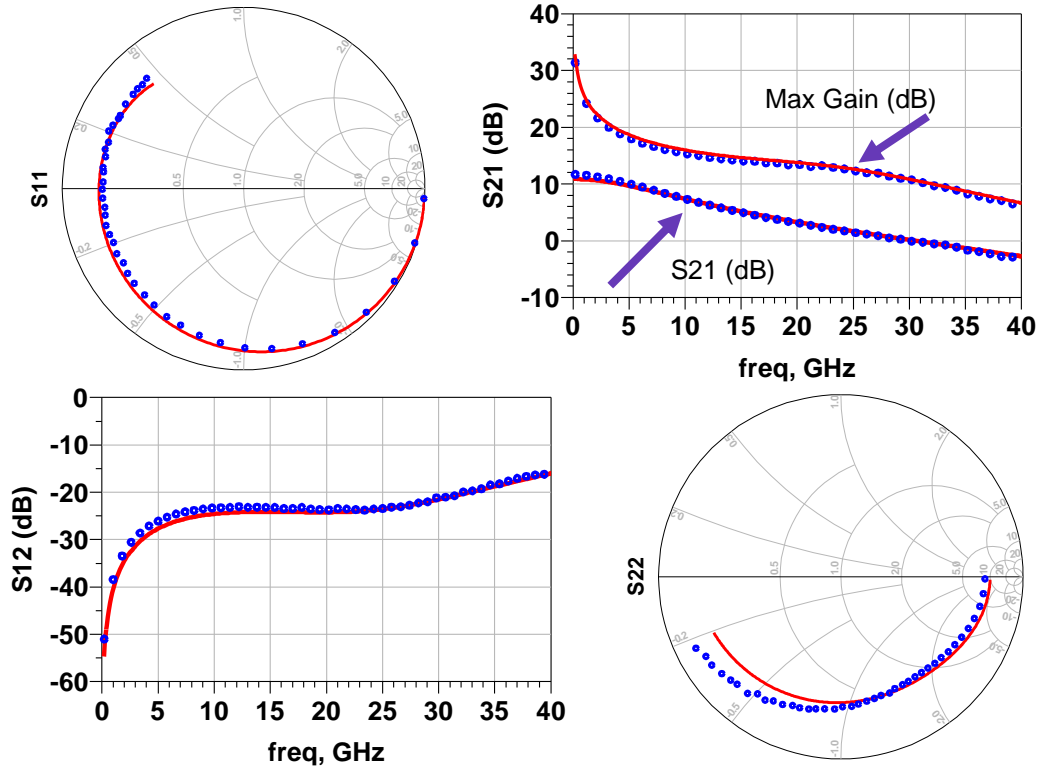

Legend: Red Solid lines - Model data, O Symbols - Measured data  
 Simulated at 25C with the frequency range from 0.2 – 40GHz. 50Ω Smith Charts  
 BWremoval = 0



Load Pull Validation: Frequency = 12GHz  
 VDS = 7V, VGS = -0.81V, IDS = 52.2mA (60% IDSS),  
 Input Power = 11dBm, Z0 = 50Ω Center, 25C

Power Tuning (0.5dB contour step)

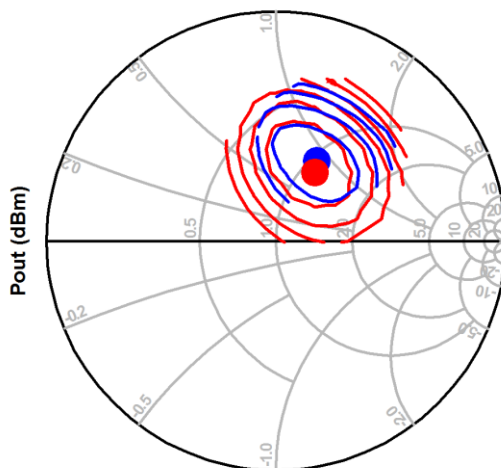

Test Bench Impedances (Ohms):

- ZS = 9.9 + j\*20.7
- ZS2 = 97.2 - j\*14.4
- ZS3 = 81.9 - j\*13.8
- ZLoad2 = 45.9 - j\*19.1
- ZLoad3 = 16.9 + j\*14.4

Efficiency Tuning (5% contour step)

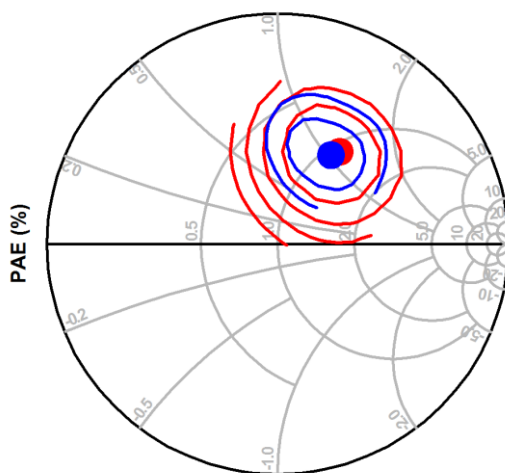

Legend: Red Solid lines – Model, Blue Solid lines – Measured, BWremoval = 0

Load Pull Summary	Max Power Load Impedance (Ohms)	Max Power Value (dBm)	Max PAE Load Impedance (Ohms)	Max PAE Value (%)
Measured	53.0 + j*43.8	23.0	53.89 + j*52.1	44.9
Model	58.3 + j*40.7	23.1	48.23 + j*50.2	47.8

Load pull data has been processed for contour display

Single Tone Power Sweep: Frequency = 12GHz  
 VDS = 7V, VGS = -0.81V, IDS = 52.2mA (60% IDSS), 25C

Load Condition: Measured Power Tuned

Transducer Gain and Power Added Efficiency (PAE)

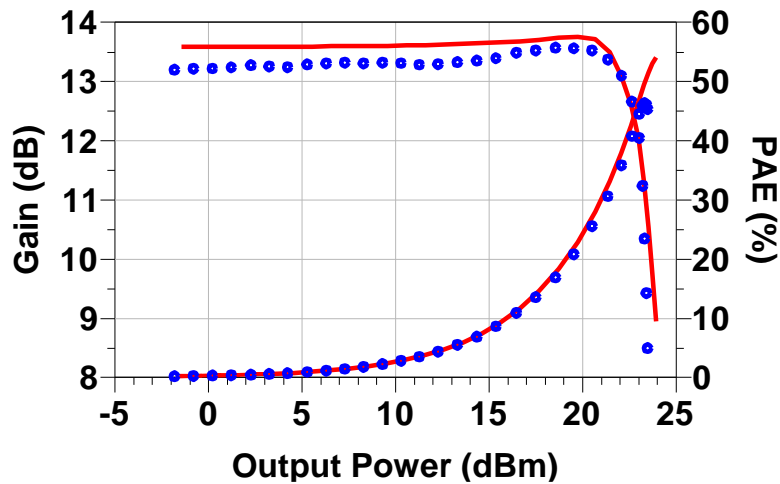

Load Condition: Power Tuned  
 Test Bench Impedances  
 (Ohms):

ZS = 9.9 + j\*20.7  
 ZS2 = 97.2 - j\*14.4  
 ZS3 = 81.9 - j\*13.8  
 ZLoad = 53.0 + j\*43.8  
 ZLoad2 = 59.1 + j\*1.0  
 ZLoad3 = 31.2 + j\*1.2

Legend: Red Solid lines - Model data, O Symbols - Measured data, BWremoval = 0

Load Condition: Measured PAE Tuned

Transducer Gain and Power Added Efficiency (PAE)

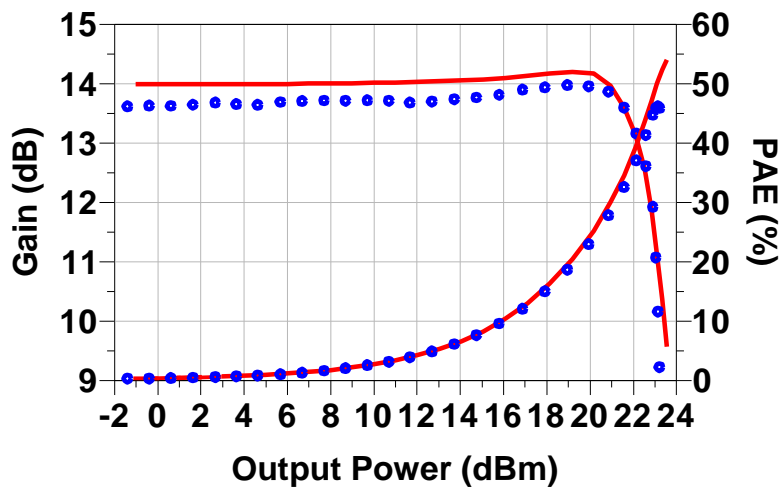

Load Condition: PAE Tuned  
 Test Bench Impedances  
 (Ohms):

ZS = 9.9 + j\*20.7  
 ZS2 = 97.2 - j\*14.4  
 ZS3 = 81.9 - j\*13.8  
 ZLoad = 53.8 + j\*52.1  
 ZLoad2 = 59.7 - j\*2.0  
 ZLoad3 = 27.2 + j\*7.1

Legend: Red Solid lines - Model data, O Symbols - Measured data, BWremoval = 0



### Advanced Model Features: Intrinsic Voltage/Current Sensing

Get Vds and Ids model data near current generator intrinsic planes while tuning.

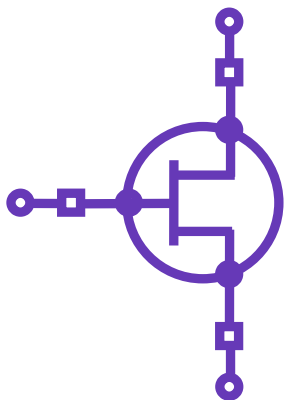

- External Model Planes
- Internal Model Planes for I/V waveform analysis
- Parasitic networks available separately from intrinsic I/V model

Example Plot of internal node Ids and Vds

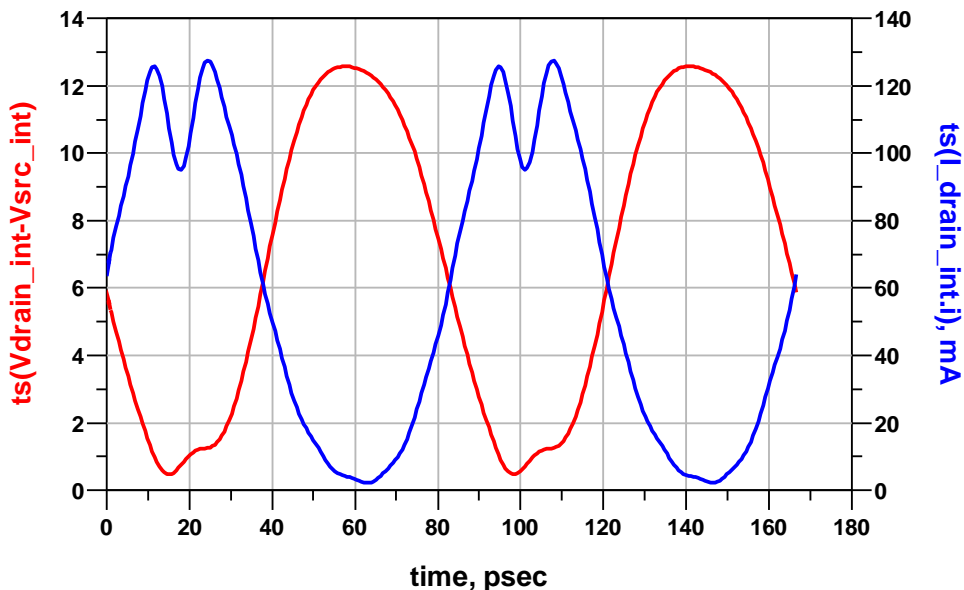

Results based on harmonic balance simulation at 19dBm input power, PAE matched at 12GHz, 7V, and 52.2mA.  $ZS = 9.9 + j*20.7$  Ohms,  $ZS2 = 97.2 - j*14.4$ ,  $ZS3 = 81.9 - j*13.8$ ,  $ZLoad = 53.0 + j*43.8$ ,  $ZLoad2 = 59.1 + j*1.0$ ,  $ZLoad3 = 31.2 + j*1.2$  Ohms

## Assembly Diagram

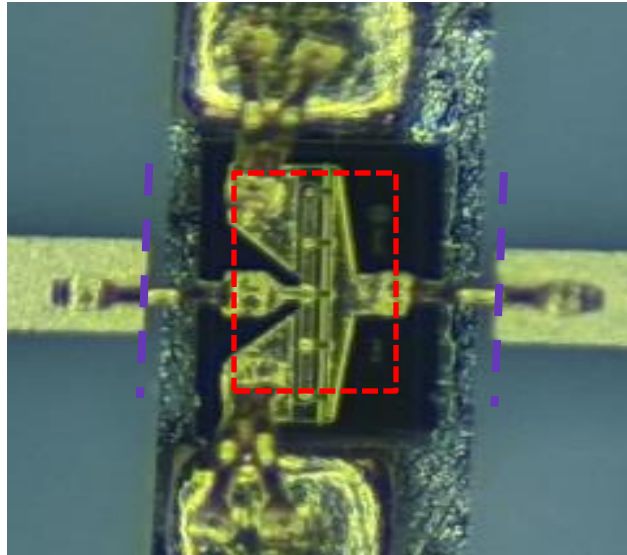

### Test fixture details:

- Device thickness: 3.93 mil
- Test board thickness: 5 mils
- Bond-wire diameter: 1 mil gold
- Gate and Drain single bond-wire length: 6 mils +/-2 (average)
- Source bond-wire length (two wires per source pad): 6 mils +/-2 (average)
- Metal standoff external next to each source pad is 4 mils thick, its purpose is to shorten the bondwire lengths to the source/ground.
- Blue line is model planes with bondwires ON (BWremoval=0)
- Red line is model planes with bondwires OFF (BWremoval=1)

## Model and Datasheet Revision Notes

12/27/2022      Original model and datasheet development